

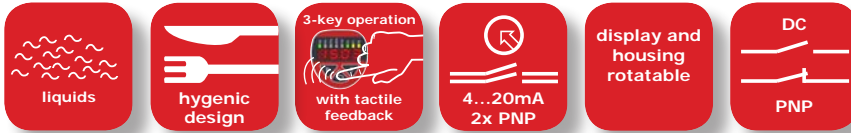

Flow switch for hygienic applications
Monitoring of flow and temperature in liquids

In brief



Application

- Hygienic and aseptic applications in
 - Food and beverage industry
 - Pharmaceutical industry
 - Biotechnology
 - Sterile process engineering

Your benefits

- **Wide range of applications**
- Flow velocities from 3cm/s to 300cm/s
- Wide process temperature range -20°C to $+85^{\circ}\text{C}$
- High process pressure tightness up to 50bar and high protection class IP65/IP67
- Elastomer-free and free of dead space metallic sealing connection
- Wide environmental temperature range -40°C to $+85^{\circ}\text{C}$
- Wear-free calorimetric sensor
- High accuracy – fast response time
- Integrated evaluation electronic: Digital display, function LED's, keyboard / 2x PNP switch output / 1x current output 4...20mA / Connector plug M12
- **High operating comfort:** enclosure and display rotatable for *optimal operability* in each installation position
- Robust high brightness LED display for *best readability*
- 3-key operation without additional assistance with tactile feedback
- Menu navigation based on VDMA standard

Description

Due to the device construction with flow velocities from 3cm/s to 300cm/s, process temperatures from -20°C to $+85^{\circ}\text{C}$, process pressures up to 16bar, process material stainless steel V4A as well as the availability of a variety of process connections like elastomer-free and free of dead space metallic sealing connection, EHEDG-/3A-/FDA-conformal, Varivent® – on request, dairy coupling DIN 11851 – on request, Tri-Clamp® / Clamp DIN 32676 / Clamp ISO 2852 – on request, aseptic tube coupling DIN 11864-1-A – on request, DRD, APV-Inline, BioControl®, SMS, flanges acc. to DIN and ISO – on request the device is especially suitable for the use for food and beverage industry, for pharmaceutical industry, for biotechnology and for sterile process engineering.

The flow switch is suitable for demanding measuring requirements.

Due to its high accuracy and the high flexibility of configuration, the device can be suited a wide variety of applications.

The process connection with metallic sealing has been specifically designed for the hygienic, dead-space and elastomer-free process adaption. The robust design and the high-quality workmanship turns the device into a very high quality product, which even the most adverse environmental conditions cannot affect, whether the lowest temperatures when used outdoors, extreme shock and vibration or aggressive media.

A captive laser marking of the type label ensures the identifiability throughout the entire lifetime of the device.

Obviously is the optional marking of a measurement point designation resp. TAG, a customer label or of a neutral type label, of course also per laser marking.



A LABS-free resp. silicone-free version, a factory calibration with calibration certificate and a customer specific configuration resp. preset is also optionally available like a material test certificate EN10204 3.1 or factory certifications for drink water resp. food suitability.

Customer specific special versions can be realized on request, e.g. software adaption (menu navigation, special functions, etc.), changed terminal assignment resp. connector orientation, design adaption of the user surface and special designs for the process connection.

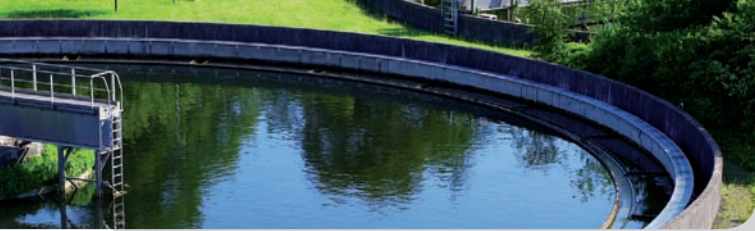

Technical data

Technical Data	
Step response time	Flow: $\leq 6s$ ($t_d = 0s / 0\% \gg 90\% / 100\% \gg 10\%$); Temperature: $\leq 4s$
Start-up time t_{On}	Flow: $\leq 10s$; Temperature: $\leq 2s$
Direct voltage	
Electronic output type	A / B / C / D
Supply voltage US	10,5...35VDC, reverse polarity protected
Residual ripple UPP	$\leq 2V_{PP} / U_{Smin} \leq U_S \leq U_{Smax}$
Supply current IIn	$\leq 100mA$ S1 / S2 = 0mA Iout = 22mA
Isolation voltage	500VAC (electrical connections – enclosure)
Universal voltage	
Electronic output type	W
Supply voltage US	20...253VAC – 48/62Hz 20...220VDC
Supply power PIn	$\leq 4VA / 2W$
Protection classification	I (EN 61140)
Overvoltage category	II (EN 60664-1)
Input	
Measurement parameter	Flow velocity
Measurement principle	calorimetric
Measurement medium	Liquids
Measurement range	3...300 cm/s / Greatest sensitivity 3...100 cm/s / Factory setting 0...100 cm/s
Temperature gradient	≥ 300 K/min
Switch output PNP S1 / S2	
Electronic output type	A / B / C / D
Function	PNP switch to +L
Output voltage UOut	$U_{Out} \geq U_S - 2V$
Output current IOut	0... $\leq 200mA$, current limited, short circuit protected
Rise time T90	$< 30\mu s$ ($R_L < 3k\Omega / I_{Out} > 4,5mA$)
Switch cycles	$\geq 100.000.000$
Switch output relay S1	
Electronic output type	W
Function	Relay changeover contact - switch to L/+L
Switching values	$\leq 2A / \leq 62,5VA / 60W$
Switch cycles	$\geq 100.000.000$
Analogue output Aout – Current 4...20mA	
Electronic output type	B / C / D
Operating range IOut	3,8...20,5mA, min. 3,6mA, max. 22mA
Permitted load RL	$\leq (U_S - 10,5V) / 20mA$
Measuring accuracy	
Accuracy	Flow: $\leq \pm 5\%$ MEV14) (5...100cm/s) / (-20°C...+85°C) / $\leq \pm 10\%$ MEV14) (100...175cm/s) / (-20°C...+85°C); Temperature: $\leq \pm 1,5K$ ($\geq 20cm/s$)
Long term drift	Flow: $\leq \pm 10\%$ MV13) / year (-20°C...+85°C)
Temperature deviation	Flow: $\leq \pm 0,4cm/s / K$ (-20°C...+85°C)
Materials	
Probe (process wetted)	Steel 1.4571/316Ti
Process connection (process wetted)	Steel 1.4404/316L / Steel 1.4571/316Ti
Gaskets (not process wetted)	FPM – fluorelastomere (e.g. Viton®)
Environmental conditions	
Environmental temperature	-20°C...+85°C
Process temperature	-20°C...+110°C; maximum -30°C...+120°C; compensated -30°C...+125°C
Process pressure	≤ 40 bar
Schutzart:	IP65/IP67 (EN/IEC 60529)

Connection

4-wire – output 2x switch PNP

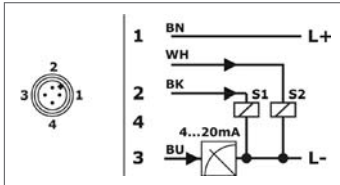

Conductor color standard connection cable M12
– A-coded: BN = brown, WH = white, BU = blue, BK = black

4-wire – output 1x switch PNP / 1x current 4...20mA

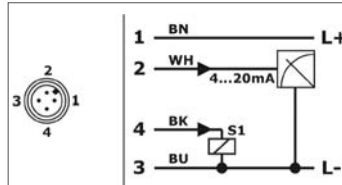

Conductor color standard connection cable M12
– A-coded: BN = brown, WH = white, BU = blue, BK = black

5-wire – output 2x switch PNP / 1x current 4...20mA

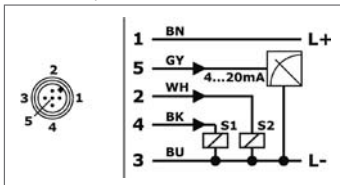

Conductor color standard connection cable M12 –
A-coded: BN = brown, WH = white, BU = blue, BK = black, GY = grey

4-wire – output 1x switch PNP / 1x current 4...20mA / Desina conformal

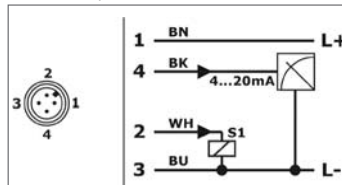

Conductor color standard connection cable M12
– A-coded: BN = brown, WH = white, BU = blue, BK = black

Fluxicont FS4LK installation

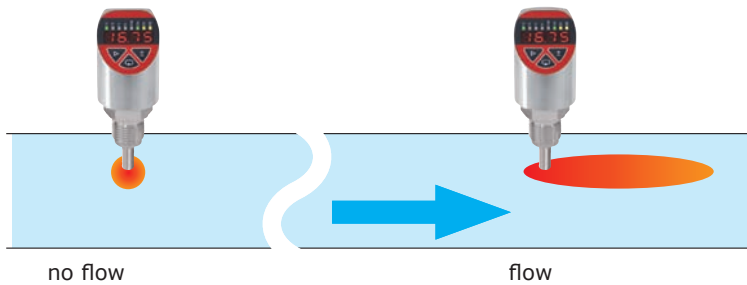

Type 2 – Thread ISO 228-1 – G $\frac{1}{2}$ " , metallic/elastomer-free sealing

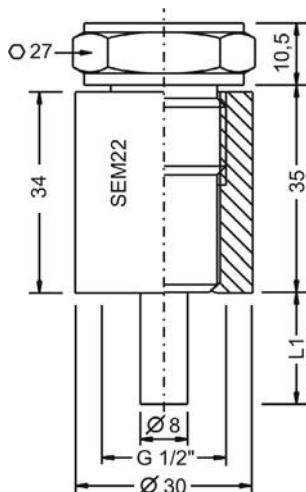

Connection housing

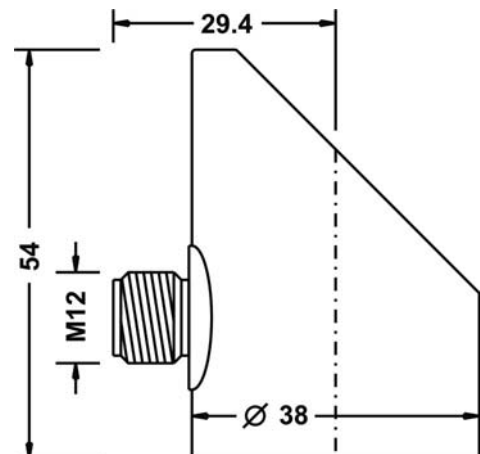

Order code

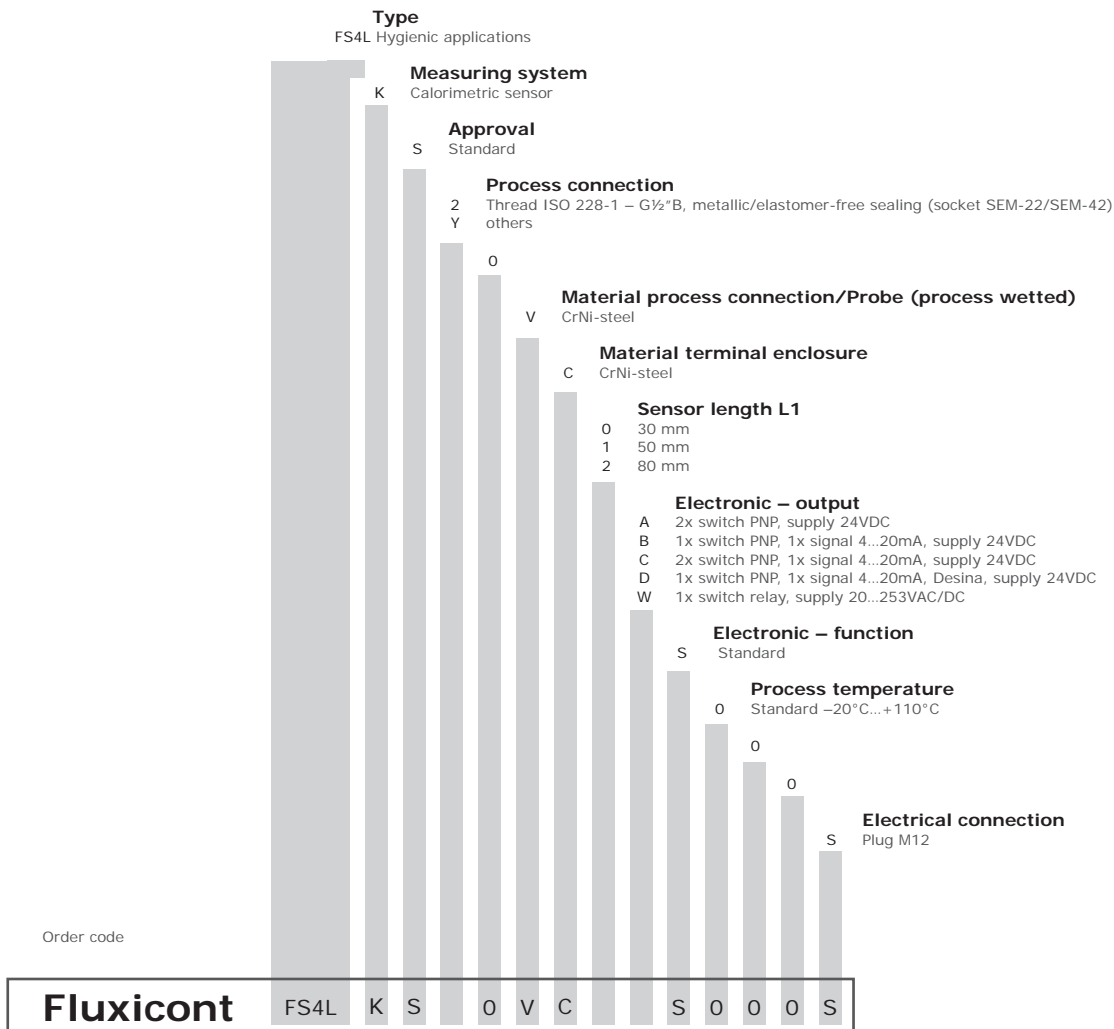

По вопросам продаж и поддержки обращайтесь:

Архангельск (8182)63-90-72
Астана +7(7172)727-132
Астрахань (8512)99-46-04
Барнаул (3852)73-04-60
Белгород (4722)40-23-64
Брянск (4832)59-03-52
Владивосток (423)249-28-31
Волгоград (844)278-03-48
Вологда (8172)26-41-59
Воронеж (473)204-51-73
Екатеринбург (343)384-55-89
Иваново (4932)77-34-06
Ижевск (3412)26-03-58
Иркутск (395) 279-98-46

Казань (843)206-01-48
Калининград (4012)72-03-81
Калуга (4842)92-23-67
Кемерово (3842)65-04-62
Киров (8332)68-02-04
Краснодар (861)203-40-90
Красноярск (391)204-63-61
Курск (4712)77-13-04
Липецк (4742)52-20-81
Магнитогорск (3519)55-03-13
Москва (495)268-04-70
Мурманск (8152)59-64-93
Набережные Челны (8552)20-53-41
Нижний Новгород (831)429-08-12

Новокузнецк (3843)20-46-81
Новосибирск (383)227-86-73
Омск (3812)21-46-40
Орел (4862)44-53-42
Оренбург (3532)37-68-04
Пенза (8412)22-31-16
Пермь (342)205-81-47
Ростов-на-Дону (863)308-18-15
Рязань (4912)46-61-64
Самара (846)206-03-16
Санкт-Петербург (812)309-46-40
Саратов (845)249-38-78
Севастополь (8692)22-31-93
Симферополь (3652)67-13-56

Смоленск (4812)29-41-54
Сочи (862)225-72-31
Ставрополь (8652)20-65-13
Сургут (3462)77-98-35
Тверь (4822)63-31-35
Томск (3822)98-41-53
Тула (4872)74-02-29
Тюмень (3452)66-21-18
Ульяновск (8422)24-23-59
Уфа (347)229-48-12
Хабаровск (4212)92-98-04
Челябинск (351)202-03-61
Череповец (8202)49-02-64
Ярославль (4852)69-52-93

Киргизия (996)312-96-26-47

Казахстан (772)734-952-31

Таджикистан (992)427-82-92-69

Эл. почта: ang@nt-rt.ru || Сайт: <http://acscontsys.nt-rt.ru/>